

54LS32/DM54LS32/DM74LS32 Quad 2-Input OR Gates

General Description

This device contains four independent gates each of which performs the logic OR function.

Features

- Alternate Military/Aerospace device (54LS32) is available. Contact a National Semiconductor Sales Office/Distributor for specifications.

Connection Diagram

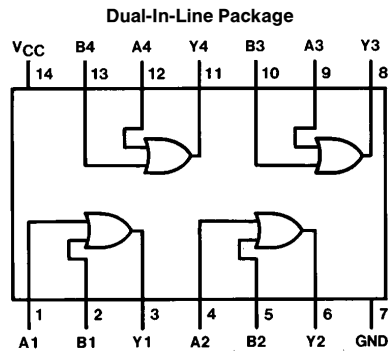

TL/F/6361-1

Order Number 54LS32DMQB, 54LS32FMQB, 54LS32LMQB,
DM54LS32J, DM54LS32W, DM74LS32M or DM74LS32N
See NS Package Number E20A, J14A, M14A, N14A or W14B

Function Table

$$Y = A + B$$

| Inputs | | Output |
|--------|---|--------|
| A | B | Y |
| L | L | L |
| L | H | H |
| H | L | H |
| H | H | H |

H = High Logic Level
L = Low Logic Level

Absolute Maximum Ratings (Note)

If Military/Aerospace specified devices are required, please contact the National Semiconductor Sales Office/Distributors for availability and specifications.

| | |
|--------------------------------------|-----------------|
| Supply Voltage | 7V |
| Input Voltage | 7V |
| Operating Free Air Temperature Range | |
| DM54LS and 54LS | −55°C to +125°C |
| DM74LS | 0°C to +70°C |
| Storage Temperature Range | −65°C to +150°C |

Note: The "Absolute Maximum Ratings" are those values beyond which the safety of the device cannot be guaranteed. The device should not be operated at these limits. The parametric values defined in the "Electrical Characteristics" table are not guaranteed at the absolute maximum ratings. The "Recommended Operating Conditions" table will define the conditions for actual device operation.

Recommended Operating Conditions

| Symbol | Parameter | DM54LS32 | | | DM74LS32 | | | Units |
|-----------------|--------------------------------|----------|-----|------|----------|-----|------|-------|
| | | Min | Nom | Max | Min | Nom | Max | |
| V _{CC} | Supply Voltage | 4.5 | 5 | 5.5 | 4.75 | 5 | 5.25 | V |
| V _{IH} | High Level Input Voltage | 2 | | | 2 | | | V |
| V _{IL} | Low Level Input Voltage | | | 0.7 | | | 0.8 | V |
| I _{OH} | High Level Output Current | | | −0.4 | | | −0.4 | mA |
| I _{OL} | Low Level Output Current | | | 4 | | | 8 | mA |
| T _A | Free Air Operating Temperature | −55 | | 125 | 0 | | 70 | °C |

Electrical Characteristics over recommended operating free air temperature range (unless otherwise noted)

| Symbol | Parameter | Conditions | Min | Typ (Note 1) | Max | Units |
|------------------|-----------------------------------|---|-------------|--------------|-------|-------|
| V _I | Input Clamp Voltage | V _{CC} = Min, I _I = −18 mA | | | −1.5 | V |
| V _{OH} | High Level Output Voltage | V _{CC} = Min, I _{OH} = Max V _{IH} = Min | DM54 2.5 | 3.4 | | V |
| V _{OL} | Low Level Output Voltage | V _{CC} = Min, I _{OL} = Max V _{IL} = Max | DM54 | 0.25 | 0.4 | V |
| | | | DM74 | 0.35 | 0.5 | |
| | | I _{OL} = 4 mA, V _{CC} = Min | DM74 | 0.25 | 0.4 | |
| I _I | Input Current @ Max Input Voltage | V _{CC} = Max, V _I = 7V | | | 0.1 | mA |
| I _{IH} | High Level Input Current | V _{CC} = Max, V _I = 2.7V | | | 20 | μA |
| I _{IL} | Low Level Input Current | V _{CC} = Max, V _I = 0.4V | | | −0.36 | mA |
| I _{OS} | Short Circuit Output Current | V _{CC} = Max (Note 2) | DM54 | −20 | −100 | mA |
| | | | DM74 | −20 | −100 | |
| I _{CCH} | Supply Current with Outputs High | V _{CC} = Max | | 3.1 | 6.2 | mA |
| I _{CCL} | Supply Current with Outputs Low | V _{CC} = Max | | 4.9 | 9.8 | mA |

Switching Characteristics at V_{CC} = 5V and T_A = 25°C (See Section 1 for Test Waveforms and Output Load)

| Symbol | Parameter | R _L = 2 kΩ | | | | Units |
|------------------|---|------------------------|-----|------------------------|-----|-------|
| | | C _L = 15 pF | | C _L = 50 pF | | |
| | | Min | Max | Min | Max | |
| t _{PLH} | Propagation Delay Time Low to High Level Output | 3 | 11 | 4 | 15 | ns |
| t _{PHL} | Propagation Delay Time High to Low Level Output | 3 | 11 | 4 | 15 | ns |

Note 1: All typicals are at V_{CC} = 5V, T_A = 25°C.

Note 2: Not more than one output should be shorted at a time, and the duration should not exceed one second.

Physical Dimensions inches (millimeters)

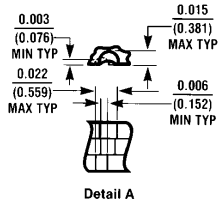
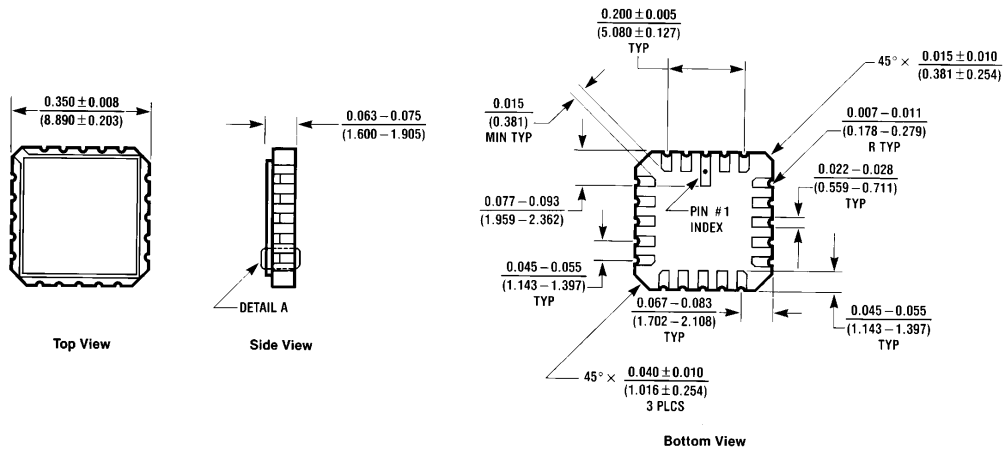

Ceramic Leadless Chip Carrier Package (E)
Order Number 54LS32LMQB
NS Package Number E20A

E20A (REV D)

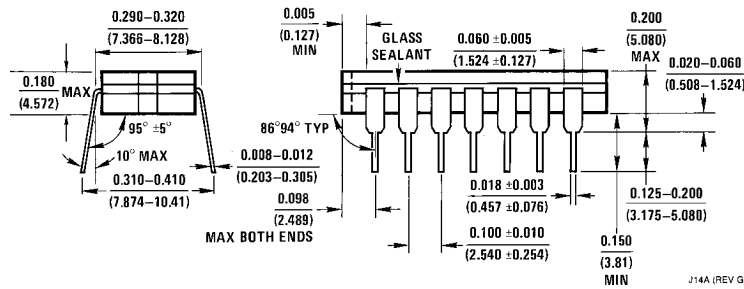
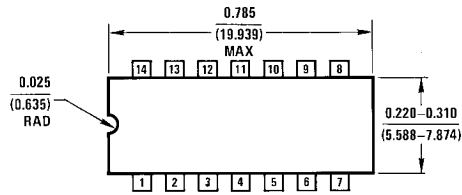

14-Lead Ceramic Dual-In-Line Package (J)
Order Number 54LS32DMQB or DM54LS32J
NS Package Number J14A

J14A (REV G)

Physical Dimensions inches (millimeters)

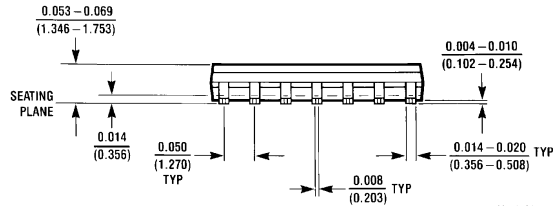

M14A (REV HI)

14-Lead Small Outline Molded Package (M)
Order Number DM74LS32M
NS Package Number M14A

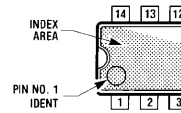
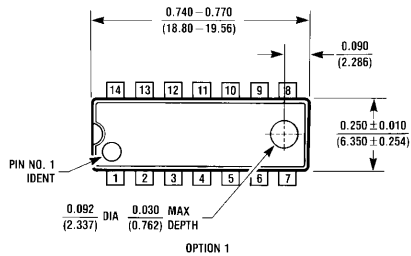

OPTION 02

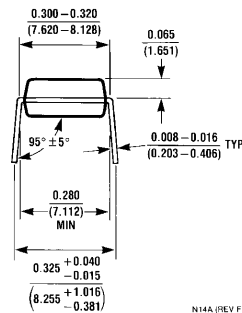
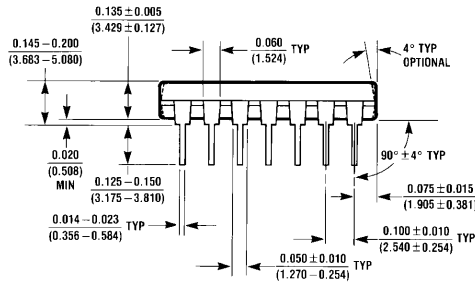

N14A (REV F)

14-Lead Molded Dual-In-Line Package (N)
Order Number DM74LS32N
NS Package Number N14A

Physical Dimensions inches (millimeters) (Continued)



14-Lead Ceramic Flat Package (W)
Order Number 54LS32FMQB or DM54LS32W
NS Package Number W14B

LIFE SUPPORT POLICY

NATIONAL'S PRODUCTS ARE NOT AUTHORIZED FOR USE AS CRITICAL COMPONENTS IN LIFE SUPPORT DEVICES OR SYSTEMS WITHOUT THE EXPRESS WRITTEN APPROVAL OF THE PRESIDENT OF NATIONAL SEMICONDUCTOR CORPORATION. As used herein:

1. Life support devices or systems are devices or systems which, (a) are intended for surgical implant into the body, or (b) support or sustain life, and whose failure to perform, when properly used in accordance with instructions for use provided in the labeling, can be reasonably expected to result in a significant injury to the user.
2. A critical component is any component of a life support device or system whose failure to perform can be reasonably expected to cause the failure of the life support device or system, or to affect its safety or effectiveness.



National Semiconductor Corporation
 1111 West Bardin Road
 Arlington, TX 76017
 Tel: 1(800) 272-9959
 Fax: 1(800) 737-7018

National Semiconductor Europe
 Fax: (+49) 0-180-530 85 86
 Email: cnjwge@tevm2.nsc.com
 Deutsch Tel: (+49) 0-180-530 85 85
 English Tel: (+49) 0-180-532 78 32
 Français Tel: (+49) 0-180-532 93 58
 Italiano Tel: (+49) 0-180-534 16 80

National Semiconductor Hong Kong Ltd.
 19th Floor, Straight Block,
 Ocean Centre, 5 Canton Rd.
 Tsimshatsui, Kowloon
 Hong Kong
 Tel: (852) 2737-1600
 Fax: (852) 2736-9960

National Semiconductor Japan Ltd.
 Tel: 81-043-299-2309
 Fax: 81-043-299-2408

National does not assume any responsibility for use of any circuitry described, no circuit patent licenses are implied and National reserves the right at any time without notice to change said circuitry and specifications.